

MODEL# SLA001-3 "SLIDE & LOCK" A-FRAME POOL LADDER



IMPORTANT INSTRUCTIONS: Read all instructions carefully & completely to become familiar with parts, assembly, safety and proper use of this product. Failure to follow these instructions may result in serious personal injury. **SWIM RESPONSIBLY & SAFELY!**

TOOLS REQUIRED: 7/16" socket, nut driver & wrench, measuring tape, Phillips (star) screwdriver, 1/8" + 1/4" drill bits & drill, pencil or marker, a level and a PAD LOCK

SAFETY INSTRUCTIONS & PROPER USE - ASSEMBLY & INSTALLATION

- This above-ground pool ladder has a 300 lb load capacity - one person - when properly installed
- This pool ladder is designed & intended for use with an above ground pool only - flat bottom pool
- Your above ground pool has shallow water - absolutely **NO DIVING** or **NO JUMPING** into the pool
- This product conforms to the latest revisions of the ANSI/APSP recommended standards for above ground / on ground swimming pool ladders
- For entry & exit of the pool, face ladder at all times. Utilize handrails for safe climbing
- This pool ladder is designed for use by only one person at all times
- This ladder is designed with a "Slide & Lock" exterior ladder section; a safety feature to assist in preventing access to the swimming pool. When pool is not in use, make certain exterior section is locked securely (**Lock not included**)
- Locate ladder on a solid base and free from high traffic areas around the pool. Use of a ladder pad is highly recommended
- Secure ladder to top rail of pool for greater stability and safety as outlined in this assembly manual
- Keep top platform and treads free from obstructions to avoid possible injury. Do not secure any items to the ladder. Such objects (eg. thermometers, play toys, ropes) may create a potential for tripping or entrapment
- **NEVER ALLOW CHILDREN TO SWIM UNATTENDED** - Nothing replaces parental supervision
- **Assemble & install this a-frame pool ladder as per the manufacturer's instructions. Do not deviate from these instructions**

PARTS INCLUDED



Ladder Section (2)



Handrails (2 each)



Support Legs (2 each)



Top Platform (1)

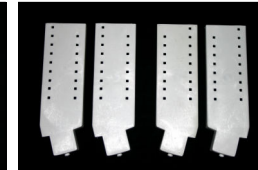

Adjustable Base Supports (2 each)



Base Treads (2)

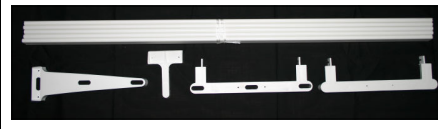

Anti-Entrapment Barrier Parts
(1 part BA, BB, BC & BD + 5 pickets)



3" Bolt



2-1/2" Carriage Bolt



3/4" Carriage Bolt



3/4" Screw



1/2" Barrier Screw



Washer



Nut

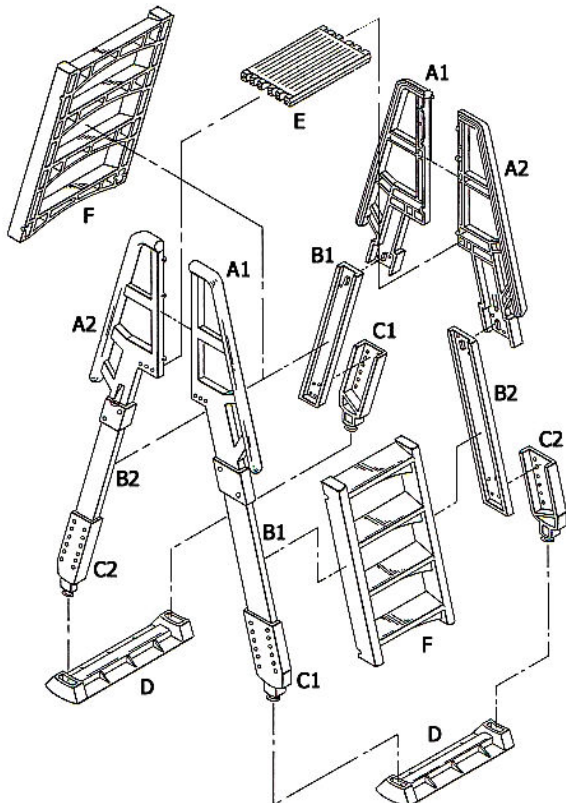

Hardware Measurement Guide

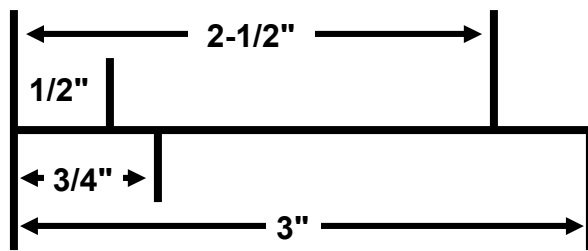

MAKE CERTAIN TO READ ALL INSTRUCTIONS CAREFULLY & IDENTIFY ALL PARTS BEFORE STARTING THE ASSEMBLY & INSTALLATION OF THIS POOL LADDER. FOR WARRANTY INFORMATION PLEASE VISIT OUR WEBSITE. REVIEW SAFETY INSTRUCTIONS BEFORE USE.

NOTHING REPLACES PARENTAL SUPERVISION
SWIM SAFELY & NEVER SWIM ALONE



877-VINYL WK



www.vinylworkscanada.com

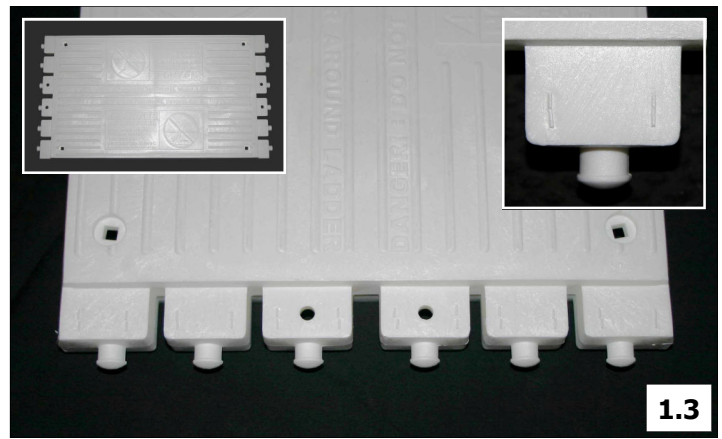
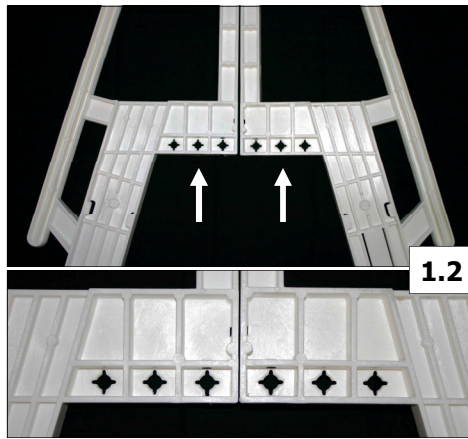
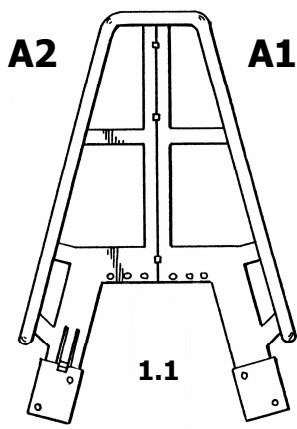

1. Position A1 & A2 handrail sets together as shown (1.1). Each handrail has holes to accept the top platform (1.2). The ends of the platform are designed to fit within these holes and snap & lock into place (1.3). Fit the platform, with anti-skid surface and warning labels facing upward, into the handrails (1.4). Gently tap outside of handrails so the button-lock tabs protrude through and secure platform in place. Make certain tabs lock securely (1.5). Repeat for both sets of handrails.

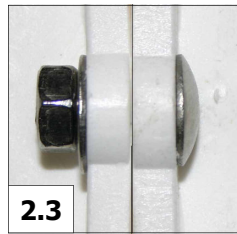
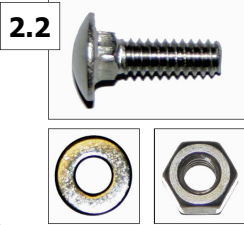
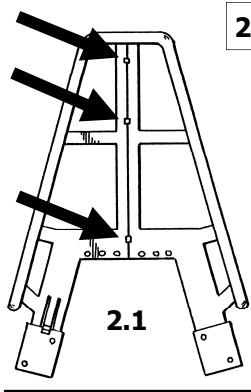
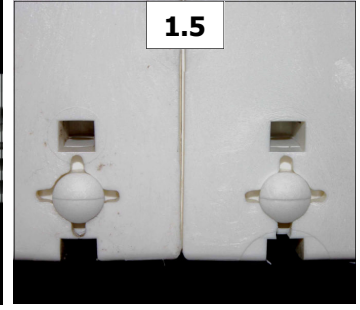

2. With top platform snapped into handrail sets, secure A1 & A2 handrails together. Use a 3/4" carriage bolt with washer & nut at each of the three positions shown (2.1-2.2). The hardware fits on the inside face of the handrails. Tighten hardware with an open end wrench (2.3). Repeat for both handrail sets.

3. Measure both the inside depth and outside height of the pool to determine the height adjustment of the ladder (Detail 3.1). Measure at the point you plan to position the ladder as the measurements may vary

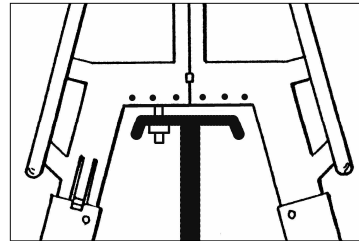

around the pool. Make certain to choose a location that has a solid base and is free from high traffic. Be advised: when the ladder is installed in the pool, the top platform of the ladder should be just above the top rail of the pool so the ladder itself, not the top rail of the pool, supports the weight load on the ladder (see 3.2). Thus, add approximately 1 inch to your measurements inside and outside of the pool. Double check your measurements and record them for use later in this assembly. **Measure accurately.**

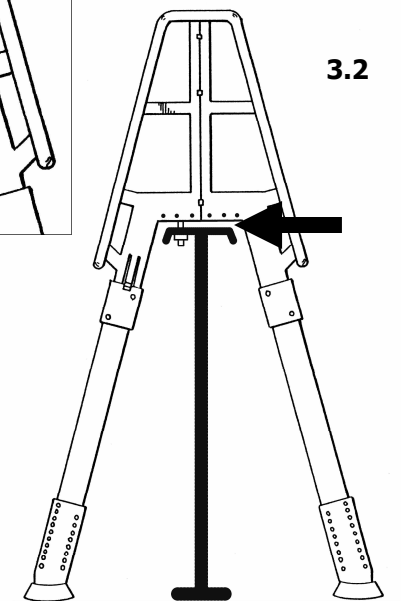

Detail 3.1

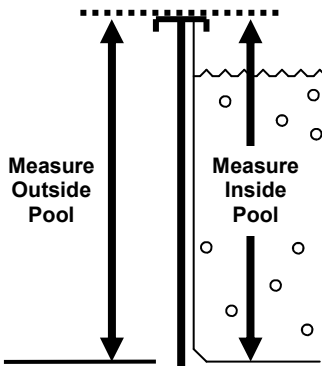

4. Understand the height adjustment. Note that the support legs B1 & B2 have measurement guides (markings) stamped in each part (4.1). Use these to set the height of the ladder both inside & outside the pool. The adjustable foot supports C1 & C2 fit over the support legs B1 & B2 respectively and align at the marking for the appropriate height required (see 4.2).

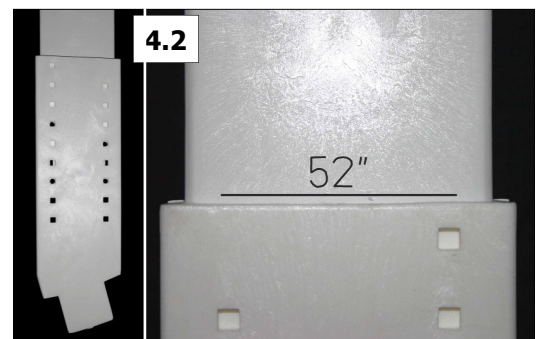
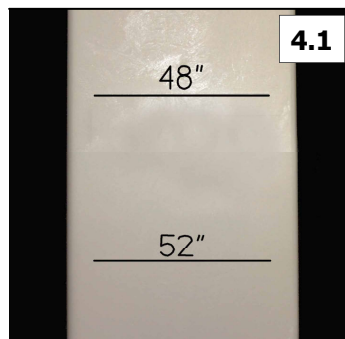



5. Lay the assembled handrails and platform on edge (5.1). Start with the top support leg positions (5.1). Identify the raised ribs on the B1 & B2 support legs (5.2). The ribs on the B1 & B2 support legs fit into a channel in the A1 & A2 handrails (5.3). Fit the B1 & B2 into the A1 & A2 handrails respectively (A1 + B1 & A2 + B2 - see 5.4 & 5.5). The bolt holes will align when the support legs are fitted into the handrails properly. Secure both “top” support legs using two 3/4 carriage bolts with washers & nuts on the inside face.

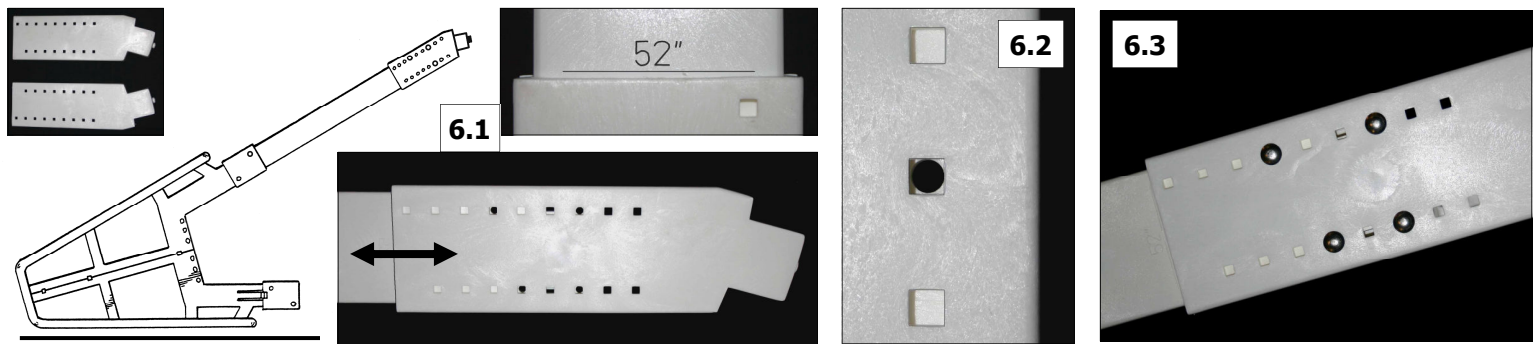
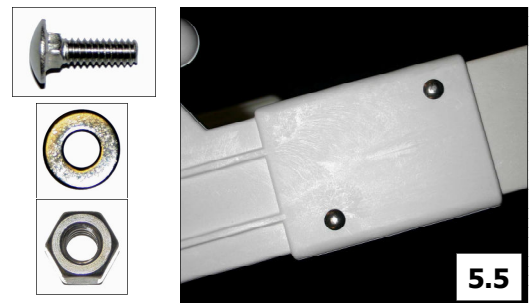

6. **NOTE:** This side of ladder will be adjusted for **OUTSIDE** of the pool. The adjustable base supports (C1 & C2) fit over the support legs (B1 & B2) at the bottom. Snap the adjustable base supports over the bottom of the support legs and slide them up / down to the **outside** measurement using the measurement guide markings (6.1). Don't forget to add approximately 1 inch for clearance above the pool (from step 3). Align square bolt holes in base supports with round bolt holes in support legs (6.2). Make certain the measurement settings of the two support legs match, the two that are assembled currently. Secure both adjustable base supports using four 3/4 carriage bolts with washers & nuts on the inside face (6.3).

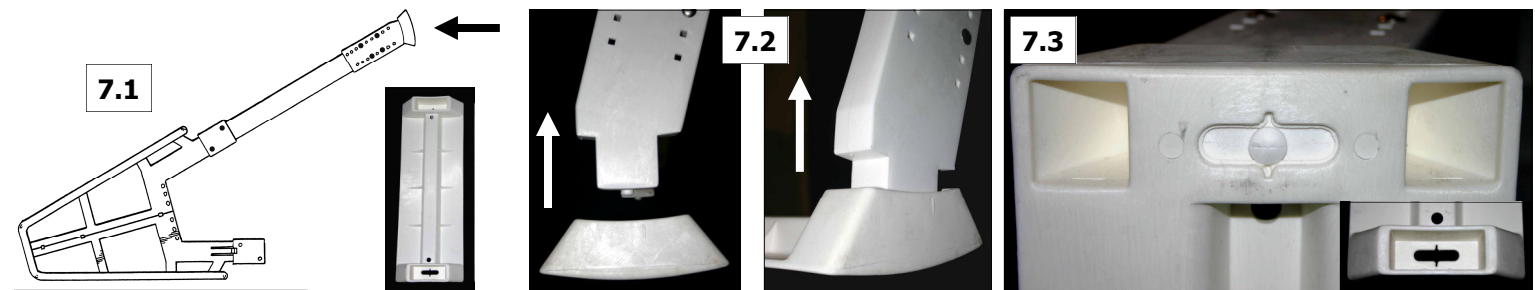

7. With the sub-assembled ladder on edge (7.1), fit a base tread D onto the C1 & C2 adjustable base supports (7.2). The base tread has a pocket at both ends that fits over the C1 & C2 base supports. The C1 & C2 base supports have a locking tab on the ends; press the base tread onto the base supports until the button-lock tab snaps through the bottom channels of the base tread (see 7.3). Position the locking tab in the center of the channel and snap firmly in place (7.4).

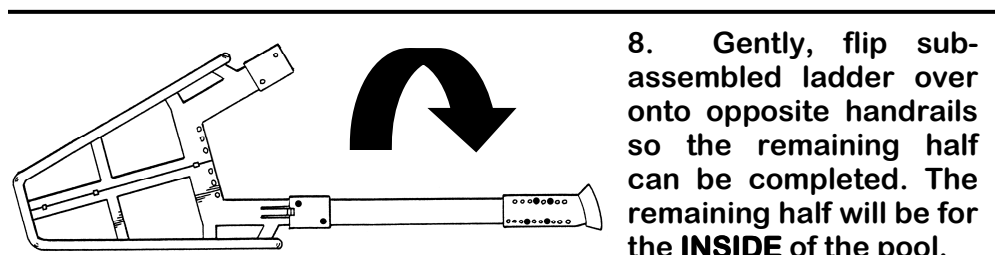

8. Gently, flip sub-assembled ladder over onto opposite handrails so the remaining half can be completed. The remaining half will be for the **INSIDE** of the pool.



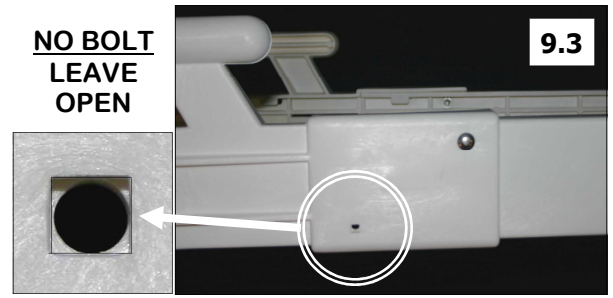
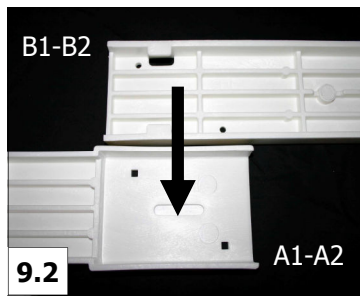
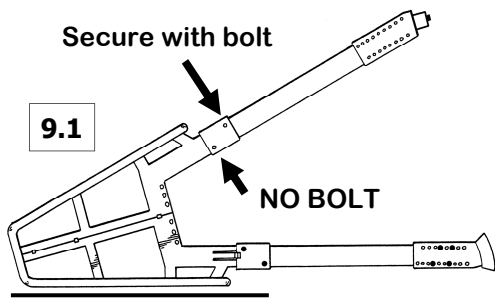

9. Similar to step 5 previously; fit two remaining support legs B1 & B2 into the A1 & A2 handrails respectively (A1+B1 & A2+B2 - see step 5 & 9.2). Secure connecting parts at **ONLY** one bolt location (see 9.1 & 9.3). The open bolt hole in parts A1-B1 & A2-B2 will be addressed in step 13 to follow. Secure with single 3/4 carriage bolt with washers & nuts on the inside face of each support leg / handrail set.

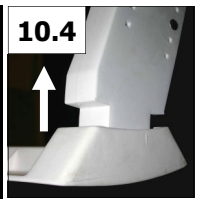
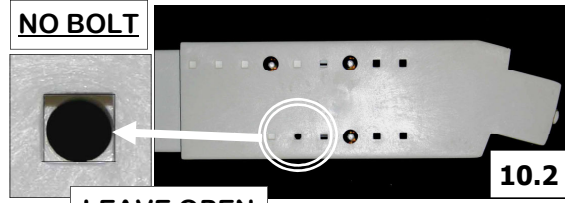
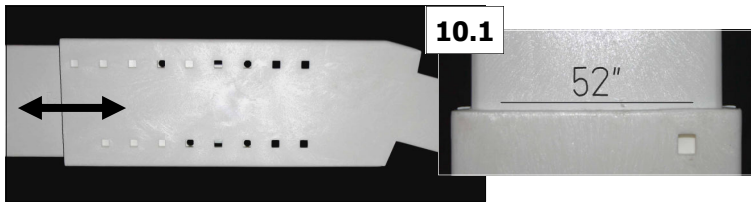

10. **NOTE:** This side of the ladder will be adjusted for the **INSIDE** of the pool. Similar to step 6; fit two remaining adjustable base supports (C1 & C2) over support legs (B1 & B2). Adjust the base supports to the **inside** measurement using the measurement guide markings (10.1). Make certain to add the 1 inch for pool clearance. Adjust both inside support legs the same. Align bolt holes & secure each base support at **ONLY** three locations (10.2 & 10.3), leaving indicated bolt hole open until step 13. Similar to step 7, fit remaining base tread D (10.4).

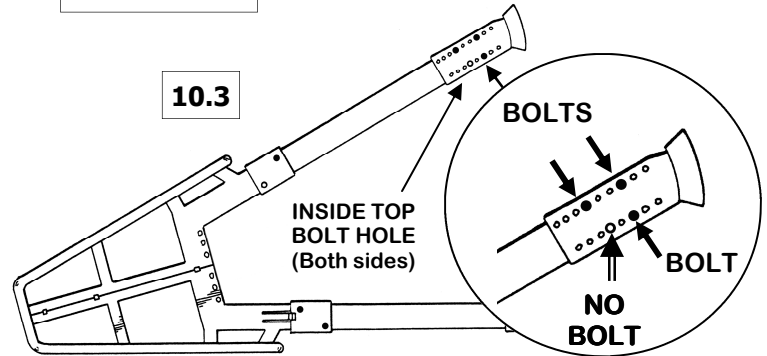

11. Stand ladder in upright position on a flat surface. Base treads are pivotal; they can be adjusted back & forth so ladder is stable. Adjust both treads appropriately (11.1). Using a 1/8 drill bit, drill a pilot hole through both ends of base tread & base support (11.2). Secure using 3/4 screw provided (11.3). Repeat for both base treads

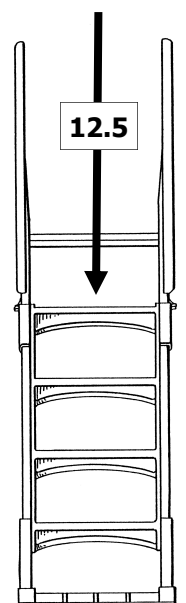
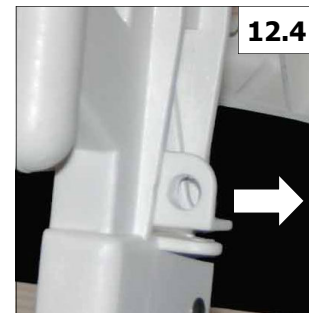
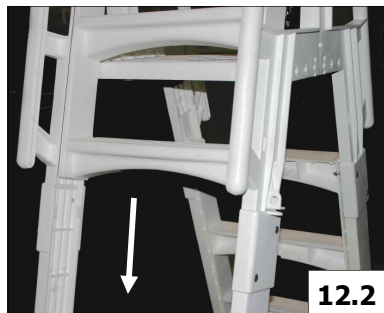
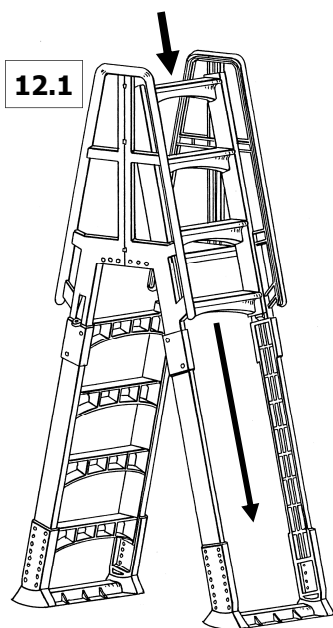
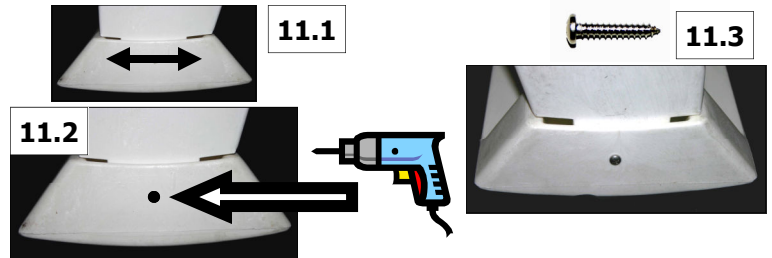

12. For both inside (in-pool) & outside (exterior) portions of ladder, fit ladder sections F into assembled frame. Slide ladder sections down the channels of the handrails and support legs, left and right, from top to bottom (12.1 & 12.2). The ladder section will only slide down as far as the catch of the locking mechanism (12.3). Using the finger hole on the outside of the locking mechanism (A2 handrail - right side) pull the locking mechanism out allowing the ladder section to continue to slide down (12.4). Gently fit & slide ladder sections down to bottom on both sides of the ladder (12.5).

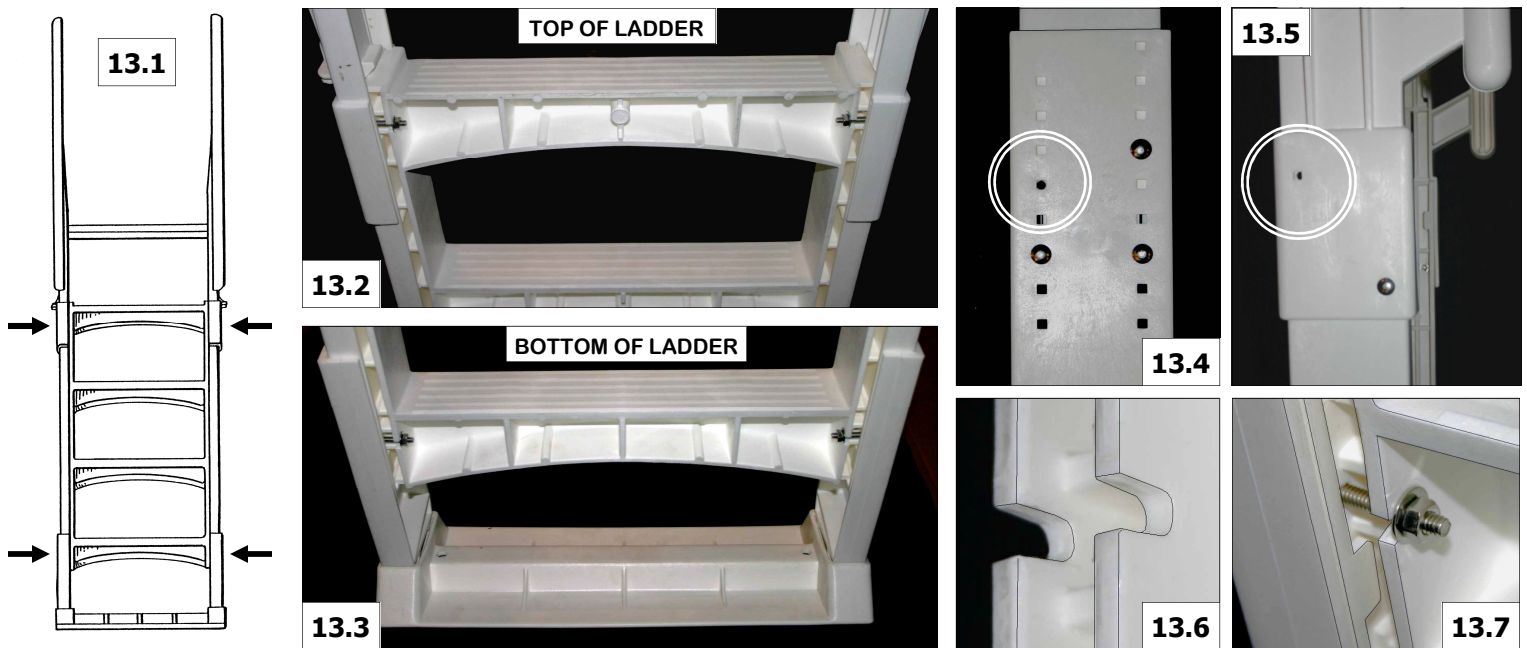

13. VERY IMPORTANT - SECURE IN-POOL LADDER SECTION. The inside / in-pool ladder section F must be secured in place for greater strength & stability. The inside ladder section **MUST NOT** be allowed to slide up. Identify the inside / in-pool side of your ladder with the “missing” hardware connection points from steps 9 & 10. Make certain ladder section F is all the way to the bottom. At the four bolt locations identified in 13.1 (left from step 9 & 10 - see 13.4 & 13.5), pass a 2-1/2 carriage bolt through the open bolt hole, from the outside in, and secure using a washer and nut (13.7). The bolts will pass through an open slot in the ladder section at all four corners (see 13.2, 13.3 & 13.6), two at the top of the ladder section and two at the bottom. Tighten all four bolts equally to slightly beyond snug - as you tighten, you will see the washer and nut pull the ladder section tight to the support frame. Do not over-tighten.

14. VERY IMPORTANT - COMPLETE ASSEMBLY AND INSTALLATION OF ANTI-ENTRAPMENT LADDER BARRIER ON REVERSE OF THIS PAGE BEFORE INSTALLING LADDER INTO THE POOL. The barrier is included with this ladder to prevent children from swimming through or behind pool ladder. Failure to complete assembly & installation may result in serious personal injury or drowning.

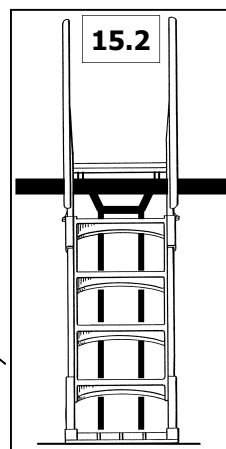
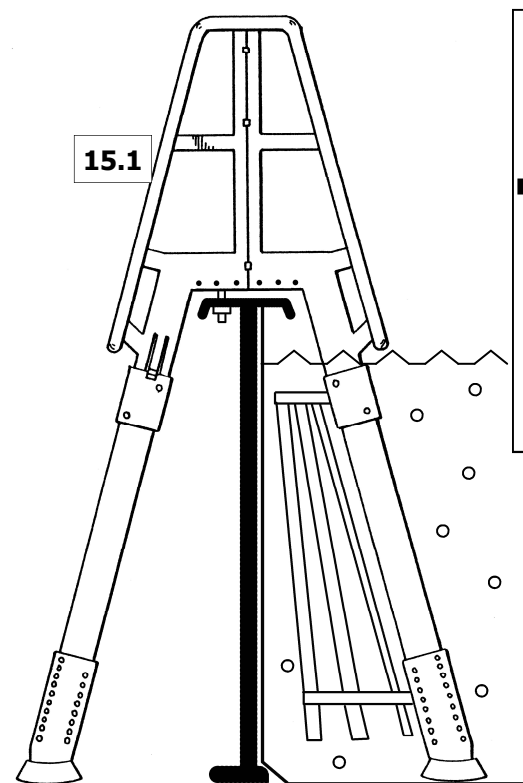

15. Position ladder in the pool at desired location (15.1) making certain the anti-entrapment barrier is away from the pool liner. Position ladder above an upright support post of pool for greater stability (15.2). You **MUST** secure the ladder to the pool top rail for strength & stability. The top platform of the ladder has 4 possible bolt holes; choose 2 that best suit your positioning & pool top rail. Mark bolt locations on pool top rail & drill 1/4" holes. Using the 3" bolts, washers & nuts, secure ladder to top rail (15.3). Tighten hardware. **IMPORTANT:** When pool is not in use slide up exterior ladder section & secure with lock (15.4). Remove & store for pool closure / winterization.

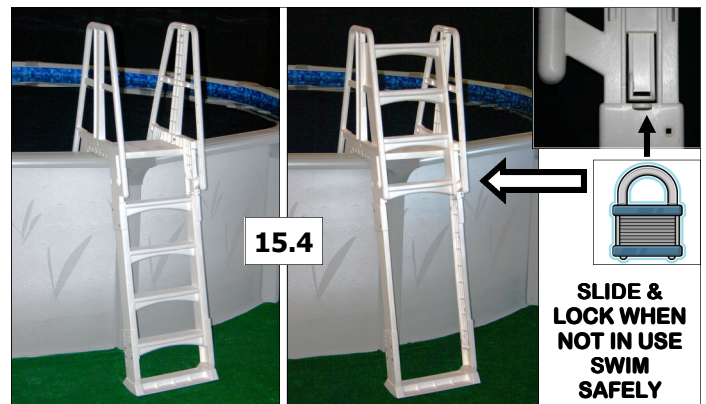
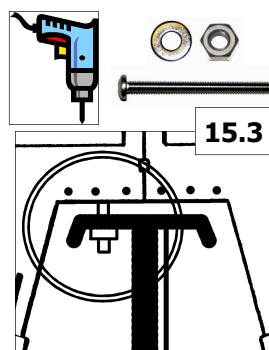

MODEL SLA001-3 - ANTI-ENTRAPMENT BARRIER INSTRUCTION

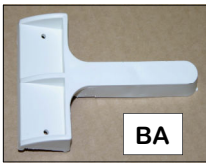

**IDENTIFY
BARRIER
PARTS**

BA

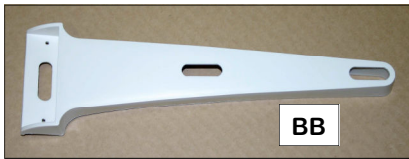

BB

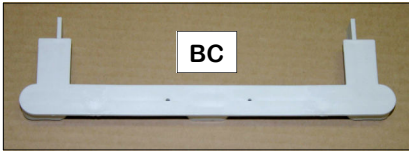

BC

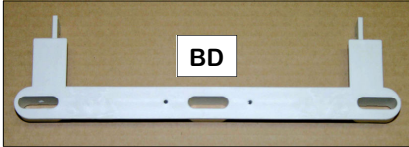

BD

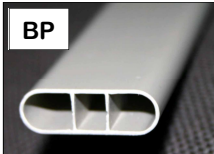

**BARRIER
PICKETS
5 PIECES**

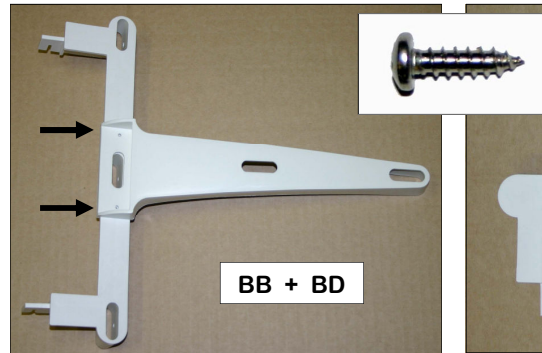
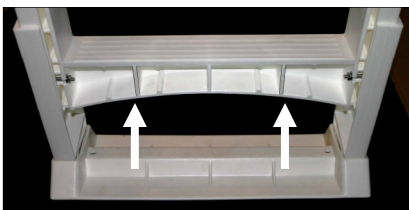

BB + BD

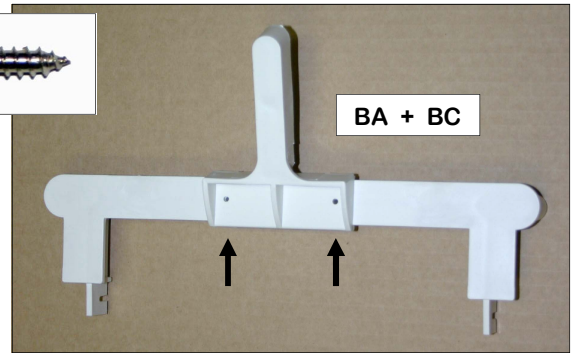

BA + BC

1. Fit parts together (BA + BC & BB + BD), align small screw holes and secure with 1/2" barrier screws as shown above

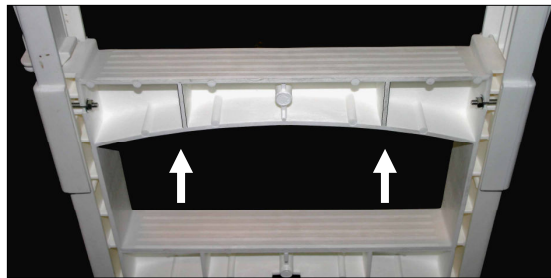

2. Fit sub-assembled BA+BC to back of in-pool ladder section F, behind top ladder tread/rung. The extended screw tabs on Part BC fit on the outside of the strengthening ribs of the tread/rung. Slide to top of ribs and secure in place using a 1/2" screw on both left & right sides.

3. Similar to step 2 above, fit sub-assembled BB+BD to back of in-pool ladder section F, behind bottom ladder tread/rung. The extended screw tabs on Part BD fit on the outside of the strengthening ribs of the tread/rung. Slide to top of ribs and secure in place using a 1/2" screw on both left & right sides

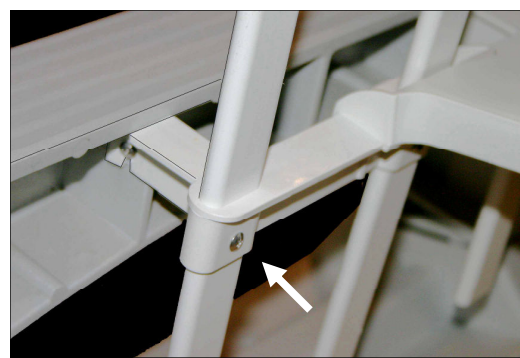

4. Fit 3 barrier pickets through slots in BB+BD at bottom & slide up into slots of BA+BC and secure all with 1/2" screws as shown by arrow



5. Fit 2 barrier pickets through slots in BB at bottom & slide up into slots of BA and secure both with 1/2" screws as shown

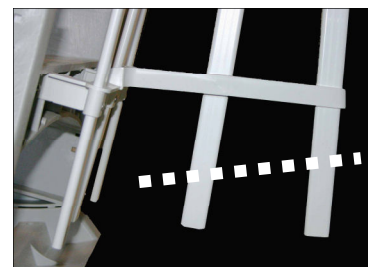

6. Trim bottom of barrier pickets if required as not to damage pool liner. Leave space between pickets and liner (6" maximum).